



# SD35

## FEATURES

- Direct bracket torque take out
- Industry standard mount pattern fits multiple caliper sizes for vehicle commonality
- Automotive pin seals to keep out dust & debris
- Forged aluminum caliper housing
- Double acting pad springs
- Bi-directional caliper allows for simplification of vehicle BOM, lower caliper PN inventory
- Multiple piston and friction material options



## SPECIFICATIONS

Max caliper pressure	125 bar
Piston Diameter	35mm
# pistons per side	2
MIN MU	0.35
MAX MU	0.55
MIN ROTOR DIA	203mm
MAX Rotor DIA	292mm
Caliper offset	23.75mm

Specifications are guidelines only and subject to change. Consult Hayes Performance Systems for specific model, part number, and assembly drawings -contact@hbpsi.com.

## REFERENCE DIMENSIONS

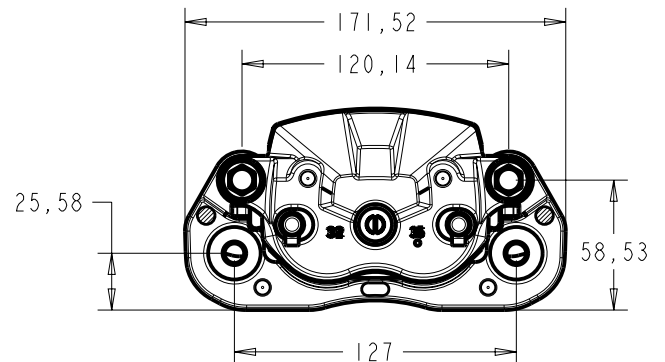

## TORQUE INFORMATION

